

TEMPLATE 4: a paper bin

Creating a cube is easy if one has a large piece of cardboard, that is big enough to cut all the sides of the cube from that single piece.

In this case, I show you an alternative to build a cube, using one single piece for each of the cube's front. The dust bin is very easy to build and helps to make use of remaining pieces of cardboard.

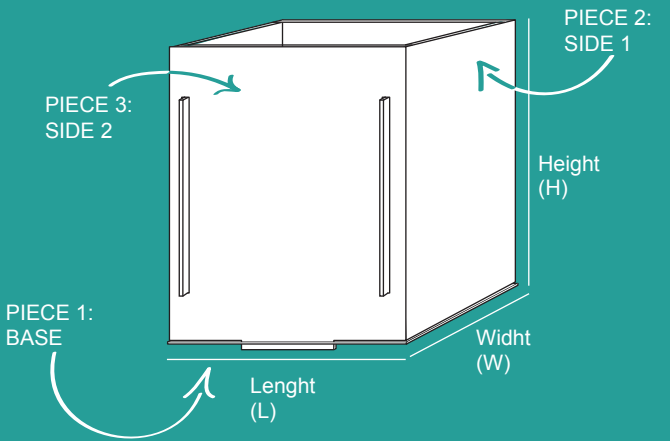
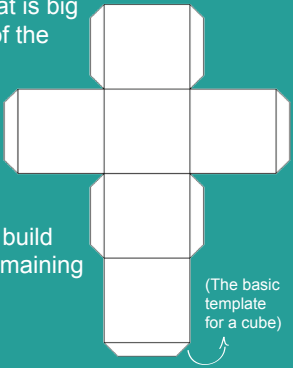

CUT THIS SHAPES:

1. Base

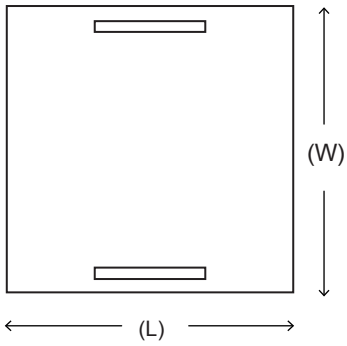

2. Side 1 (X2)

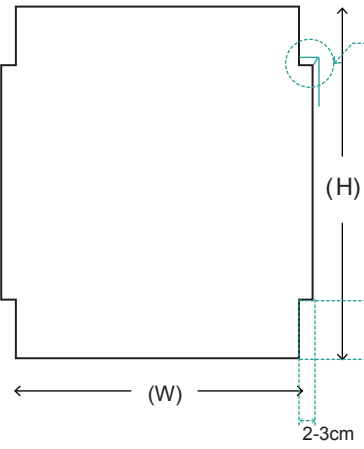

3. Side 2 (X2)

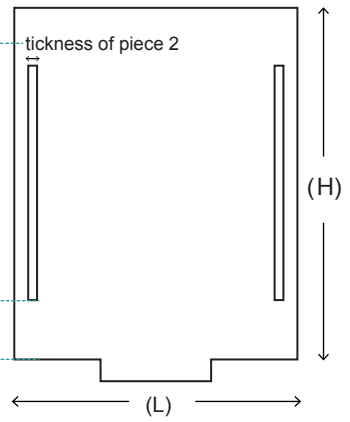

With a total of 5 pieces, you can start assembling the paper bin like this:

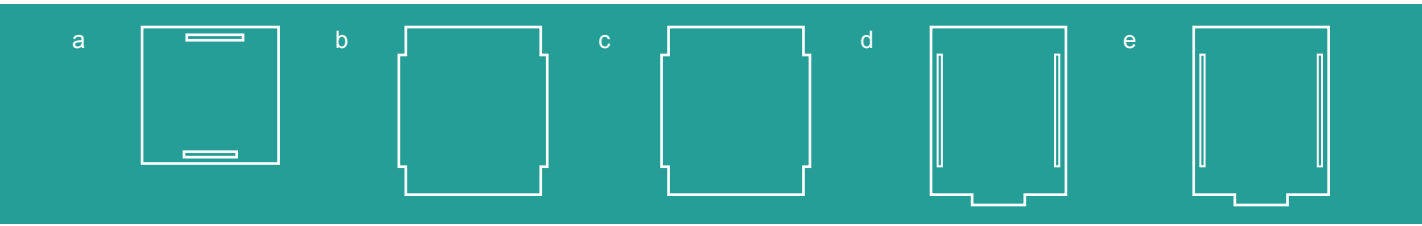

1) Piece d goes inside piece a

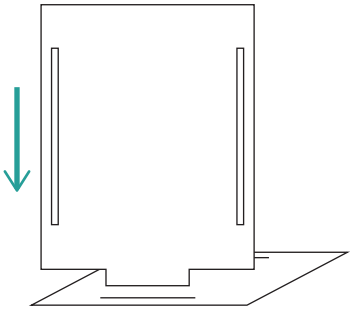

2) Piece b goes inside piece d

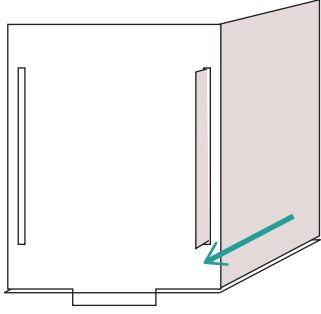

3) Piece c goes inside piece d

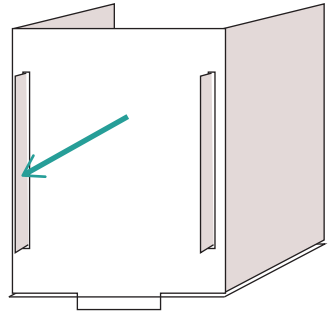

4) Piece e goes inside piece a

